

PROJECT: R-2303 A NC 24, AUTRYVILLE NC

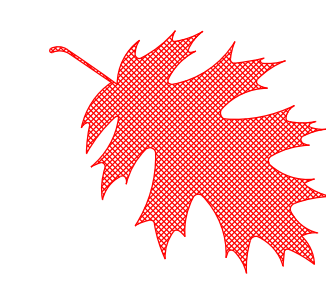

HIGHWAY LANDSCAPE DEVELOPMENT PROJECT



T.I.P. #	STATE PROJECT W.B.S. #	SHEET #	SHEET # TOTAL
R-2303A (L)	34416.3.12	L 1	8
FED. PROJ. #	DESCRIPTION	DIVISION	
-	LANDSCAPE	3	

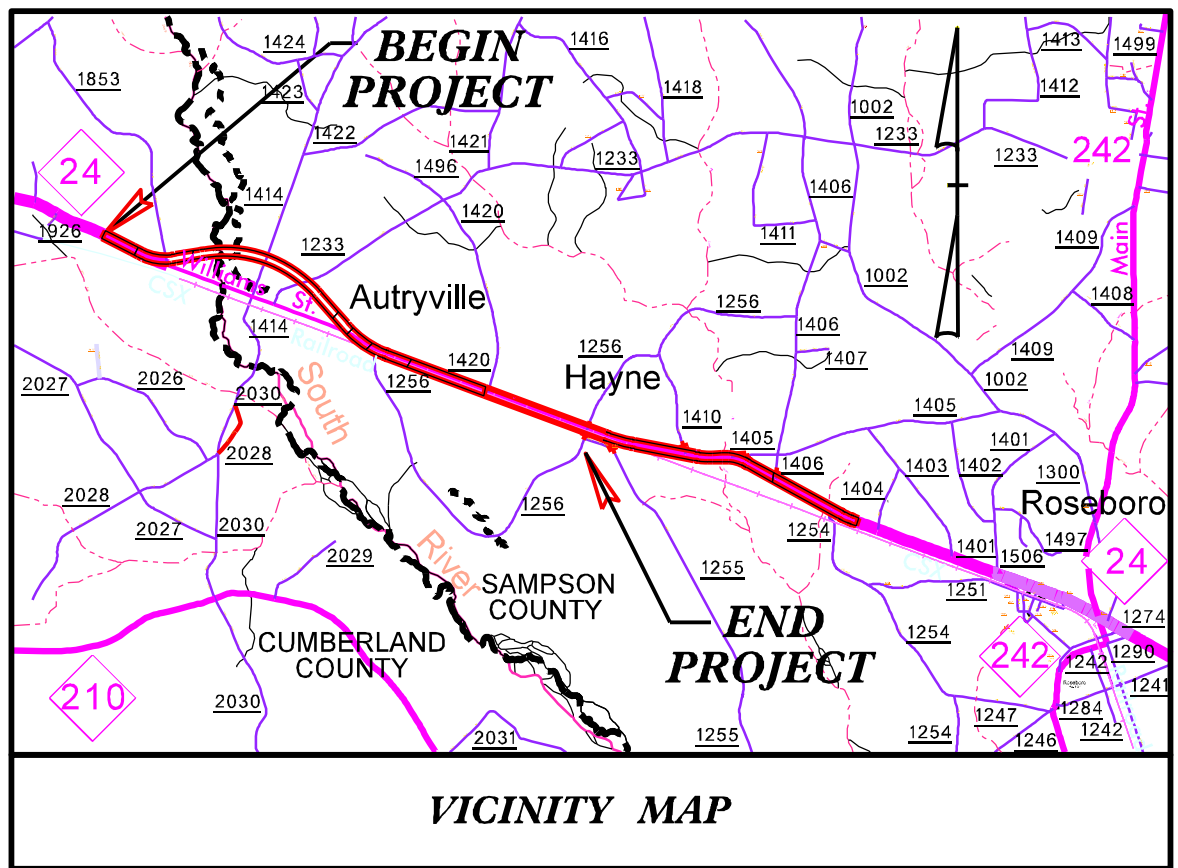

STATE OF NORTH CAROLINA DIVISION OF HIGHWAYS SAMPSON COUNTY

LOCATION: NC 24 from Cumberland County line to SR 1256 (Horseshoe Rd) in Sampson County

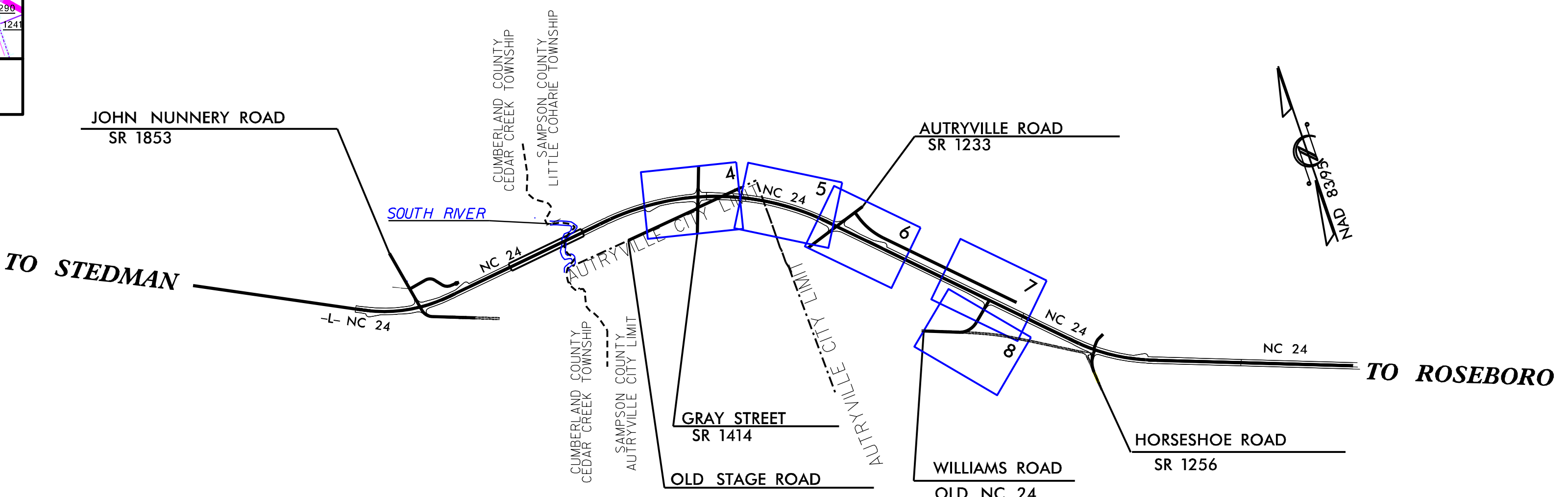
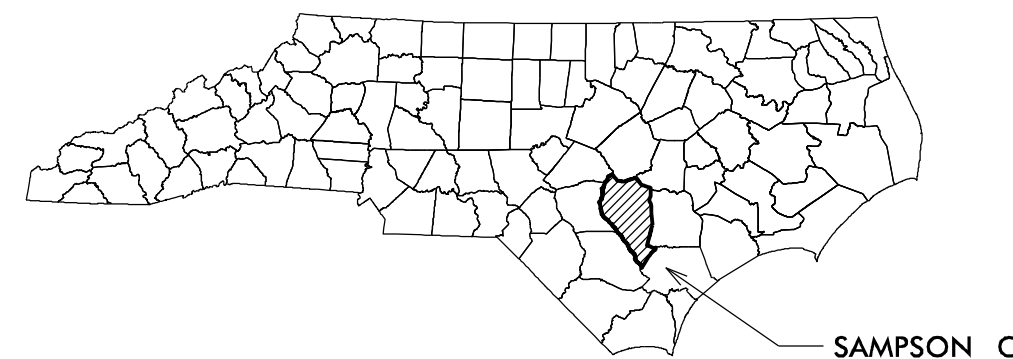

SUMMARY OF QUANTITIES

Qty.	Unit	Botanical Name/ Item Description	Common Name	Size	Caliper	Furnish	Remarks
1	EA	<i>Quercus phellos</i>	Willow Oak	10-12'		B&B	full
32	EA	<i>Betula nigra</i>	River Birch	8-10'	3 stems	B&B	As Shown
36	EA	<i>Cercis canadensis</i>	Eastern Redbud	6-8'		B&B	As Shown
90	EA	<i>Prunus caroliniana</i>	Cherry Laurel	24-36"		#3 cont.	As Shown
30	EA	<i>Pinus palustris</i>	Long Leaf Pine	5-6'		B&B	As Shown
7	EA	<i>Juniperus virginiana</i>	Easter Red Cedar	5-6'		B&B	3-4 stem
282	CY	Mulch for Planting					
20	M/G	Water for Planting					
2	EA	Sign Structure					
50	TON	Class A Rip Rap					
16	EA	Monthly Establishment					
1	LS	Mobilization					

CONVENTIONAL SYMBOLS		
County Line.....	-----	
City or Town Line.....	-----	
Exist. Right of Way Line Marker.....	-----△-----	
Prop. Right of Way Line Marker (By Others).....	-----▲-----	
Prop Right of Way Line Marker (By Contract).....	-----▲-----	
Exist. Control of Access Line.....	-----○-----	
Prop. Control of Access Line.....	-----○-----	
Property Line.....	-----○-----	
Easement Line.....	-----○-----	
Slope Stake Line.....	-----○-----	
Exist. Fence.....	-----+-----	
Prop. Woven Wire Fence.....	-----+-----	
Prop. Chain Link Fence.....	-----+-----	
Exist. Road.....	-----=-----	
Prop. Road.....	-----=-----	
Guardrail.....	-----T-----	
Survey Line.....	-----+-----	
Denotes Line Equality.....	-----+-----	
Bridge.....	-----+-----	
Culvert.....	-----+-----	
Railroad.....	-----+-----	
Woods.....	-----+-----	
Exist. Telephone Pole.....	-----+-----	
Prop. Telephone Pole.....	-----+-----	
Tower Pole and Line.....	-----+-----	
Exist. Power Pole.....	-----+-----	
Prop. Power Pole.....	-----+-----	
Sanitary Sewer Line.....	-----+-----	
Water Line.....	-----+-----	
Gas Line.....	-----+-----	
Picnic Shelter.....	-----+-----	
Regeneration.....	-----+-----	
Reforestation.....	-----+-----	

INDEX OF SHEETS:
 L1 TITLE, DESCRIPTION, & SUMMARY OF QUAN.
 L2 PLANTING DETAILS
 L3 SIGN DETAILS
 L4- L8 LANDSCAPE DEVELOPMENT PLANS

PREPARED BY: BK DATE: 3/2020

DATE	REVISION DESCRIPTION
4-8-2020	Finalize Plans & Details

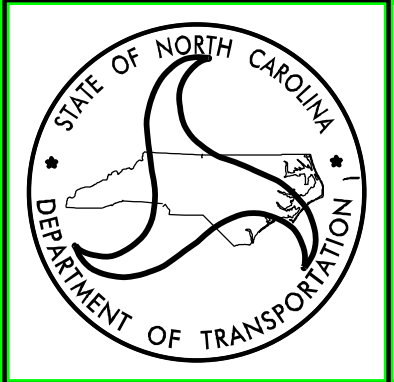

STATE OF NORTH CAROLINA DEPARTMENT OF TRANSPORTATION

LOCATION: AUTRYVILLE NC
 TYPE of WORK: LANDSCAPE DEVELOPMENT
 COUNTY: SAMPSON COUNTY

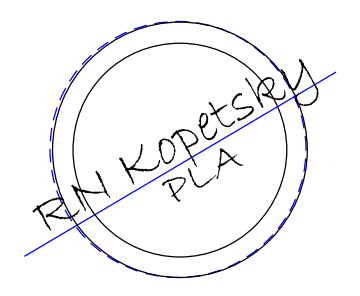

2014 American Standard for Nursery Stock
 2018 NCDOT STANDARD SPECIFICATIONS
 PREPARED IN THE OFFICE OF:
 NCDOT- ROADSIDE ENVIRONMENTAL UNIT
 LANDSCAPE DESIGN & DEVELOPMENT SECTION
 1557 MAIL SERVICE CENTER
 RALEIGH NC 27699 919-707-2920

\$\$\$\$\$SYTIME\$\$\$\$\$
\$\$\$\$\$SYTIME\$\$\$\$\$
\$\$\$\$\$SYTIME\$\$\$\$\$
\$\$\$\$\$SYTIME\$\$\$\$\$

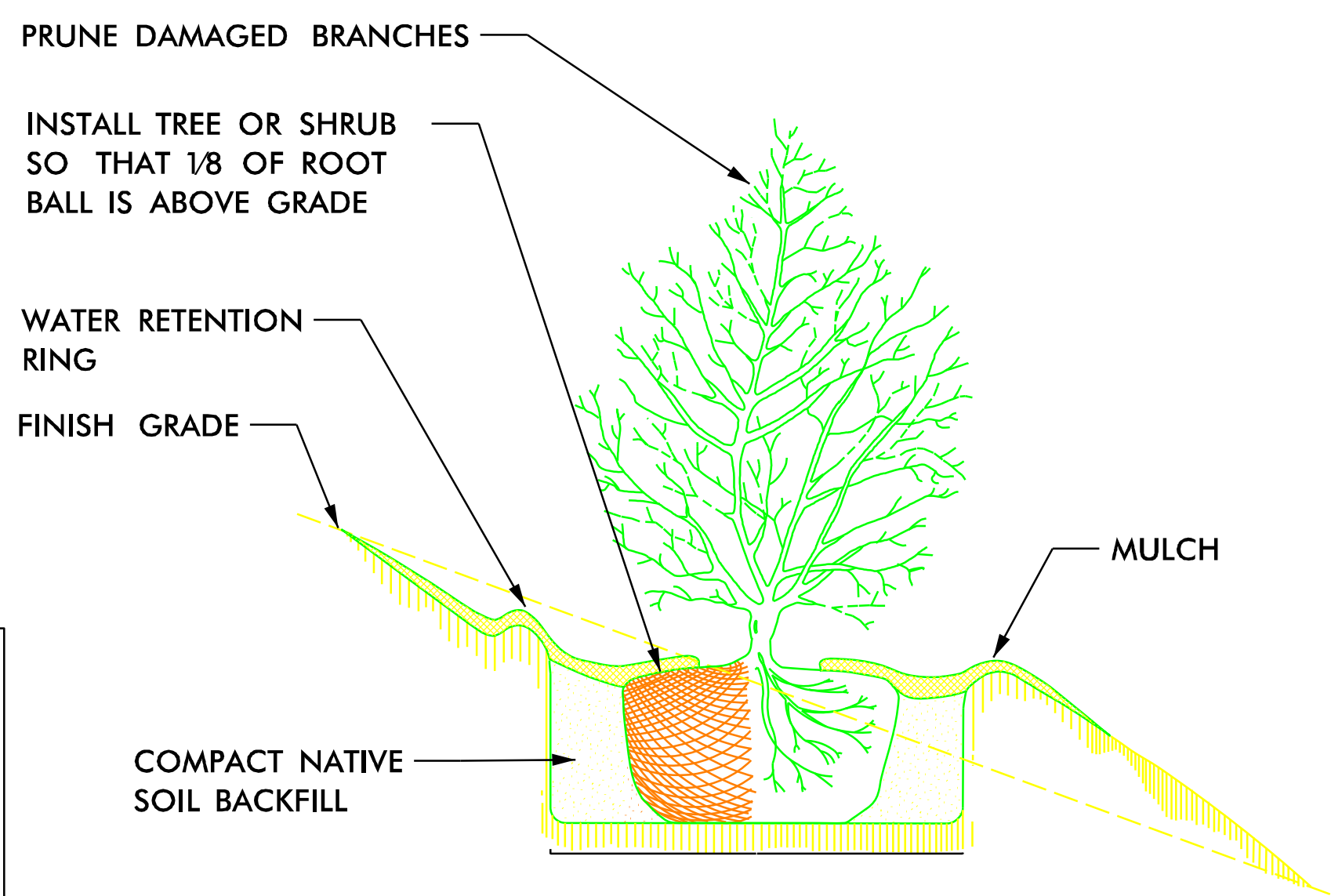
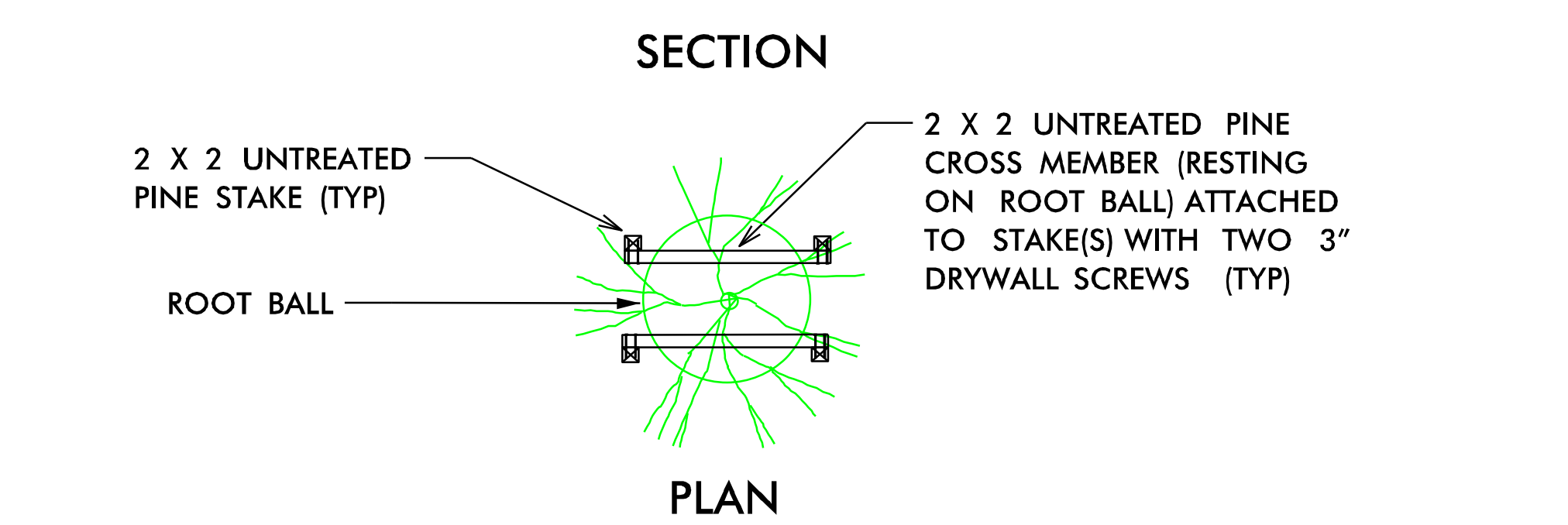
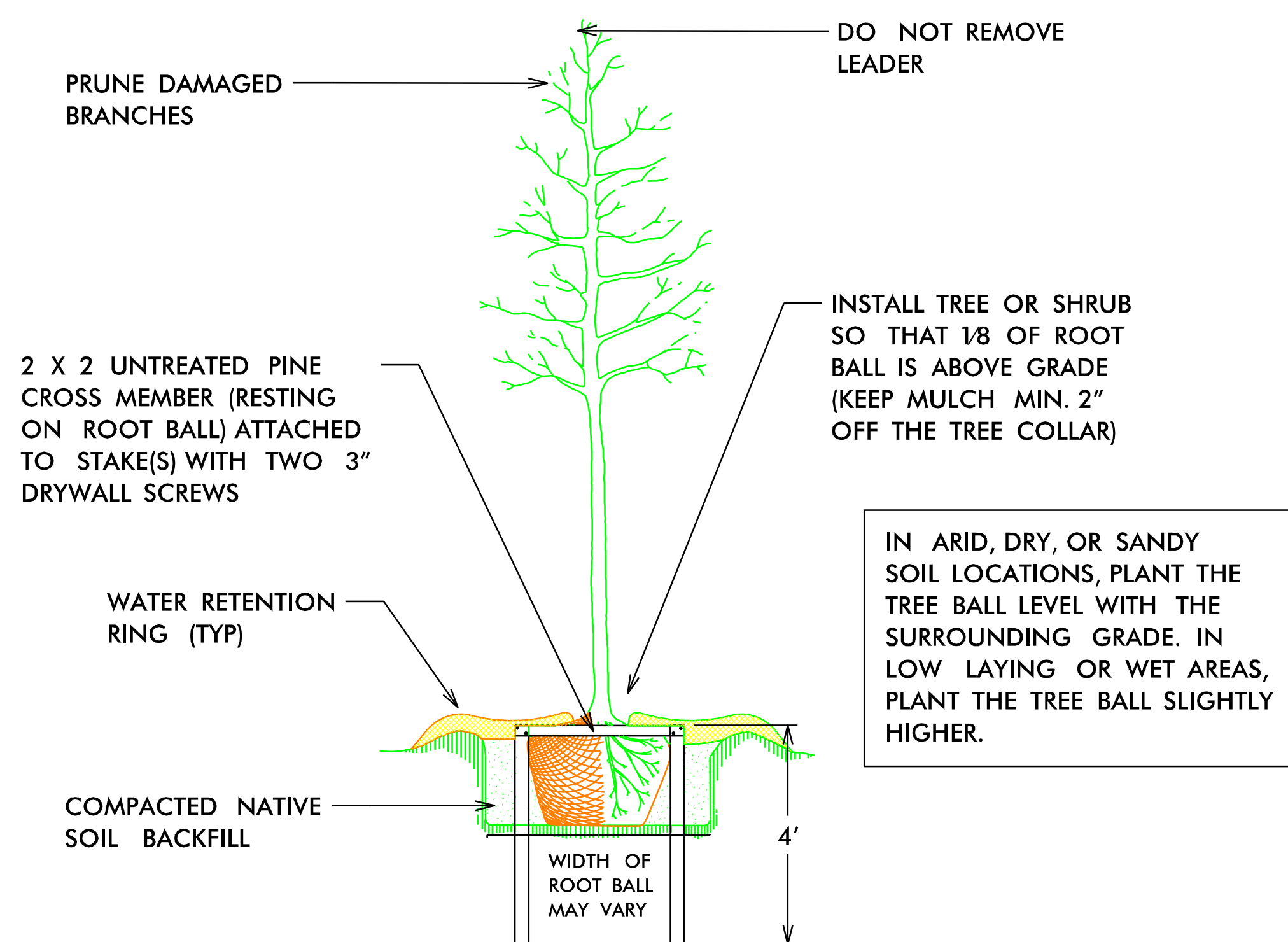

**TREE OR SHRUB PLANTING DETAIL
(SLOPING GROUND)**

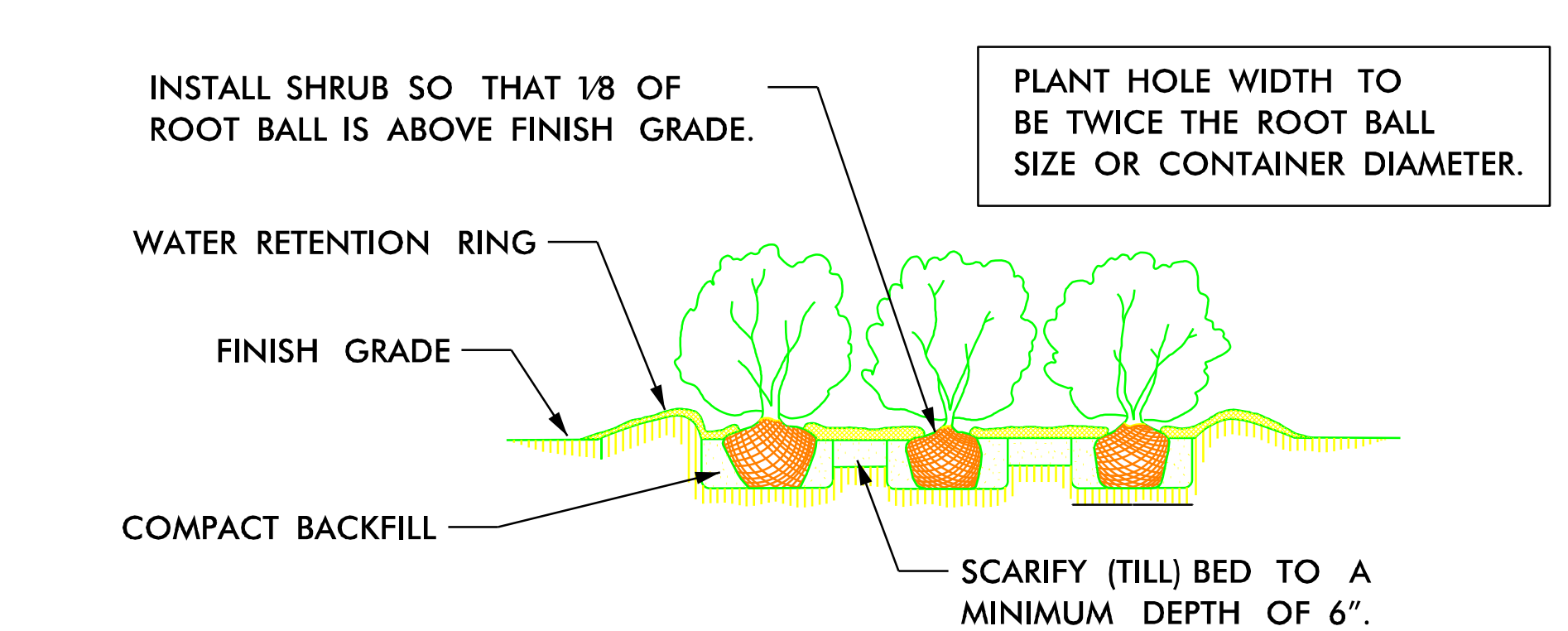

SHRUB BED PLANTING DETAIL

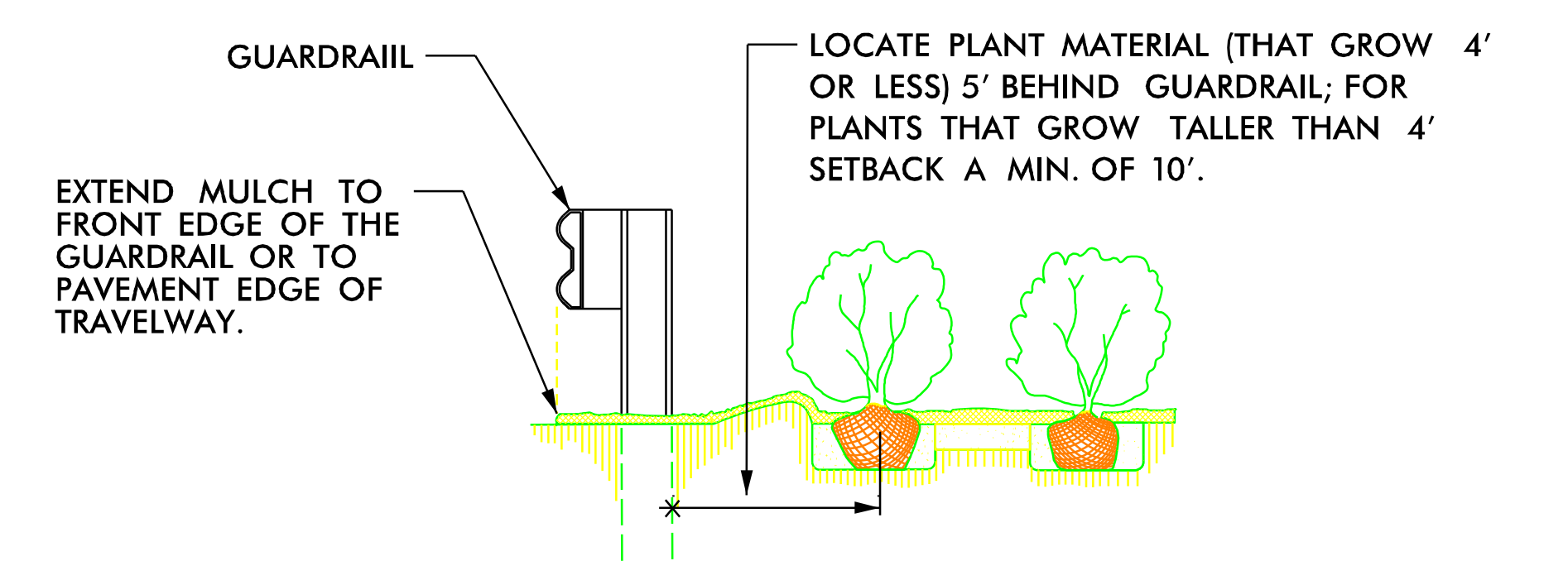

**GUARDRAIL MULCHING DETAIL
USE AS DIRECTED BY FIELD ENGINEER**

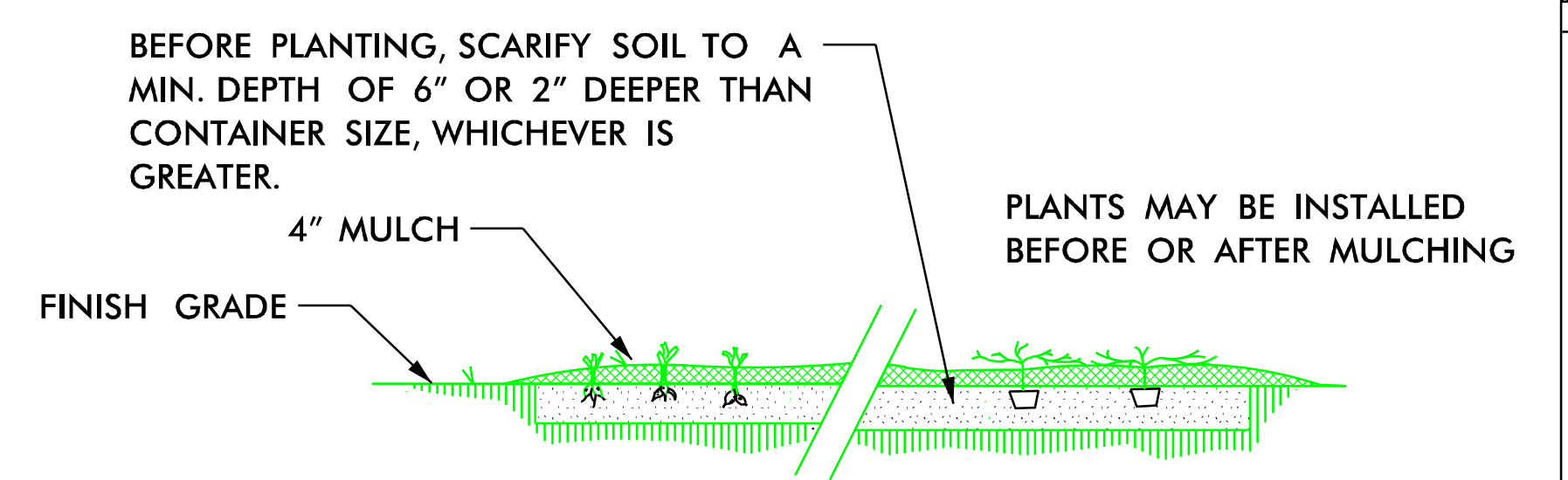

GROUND COVER/BEDDING PLANT DETAIL

NOTES:

- PLANT HOLE WIDTH TO BE TWICE THE ROOT BALL SIZE OR CONTAINER DIAMETER.
- APPLY HERBICIDES A MIN. OF 7 DAYS PRIOR TO PLANTING, BY LABEL INSTRUCTIONS, OR AS DIRECTED BY THE NCDOT ENGINEER.
- APPLY FERTILIZER AT PLANTING TIME IN THE FORM OF A SLOW RELEASE PELLET OR TABLET. APPLY AT RATE RECOMMENDED BY MANUFACTURER. BOTH RATE AND FORMULATION MUST BE APPROVED BY FIELD ENGINEER PRIOR TO APPLICATION.
- ALL PRUNING TO FOLLOW STANDARD ARBORICULTURAL PRACTICES AS SPECIFIED BY INTERNATIONAL SOCIETY OF ARBORICULTURE.
- DO NOT ATTEMPT TO STRAIGHTEN A TREE THAT HAS BEEN PLANTED AT AN ANGLE WITH THE USE OF STAKING OR GUYING. DIG TREE AND REPLANT TO UPRIGHT POSITION.

**TREE PLANTING & ROOT BALL STAKING DETAIL
(STAKE TREES 8' OR TALLER)**

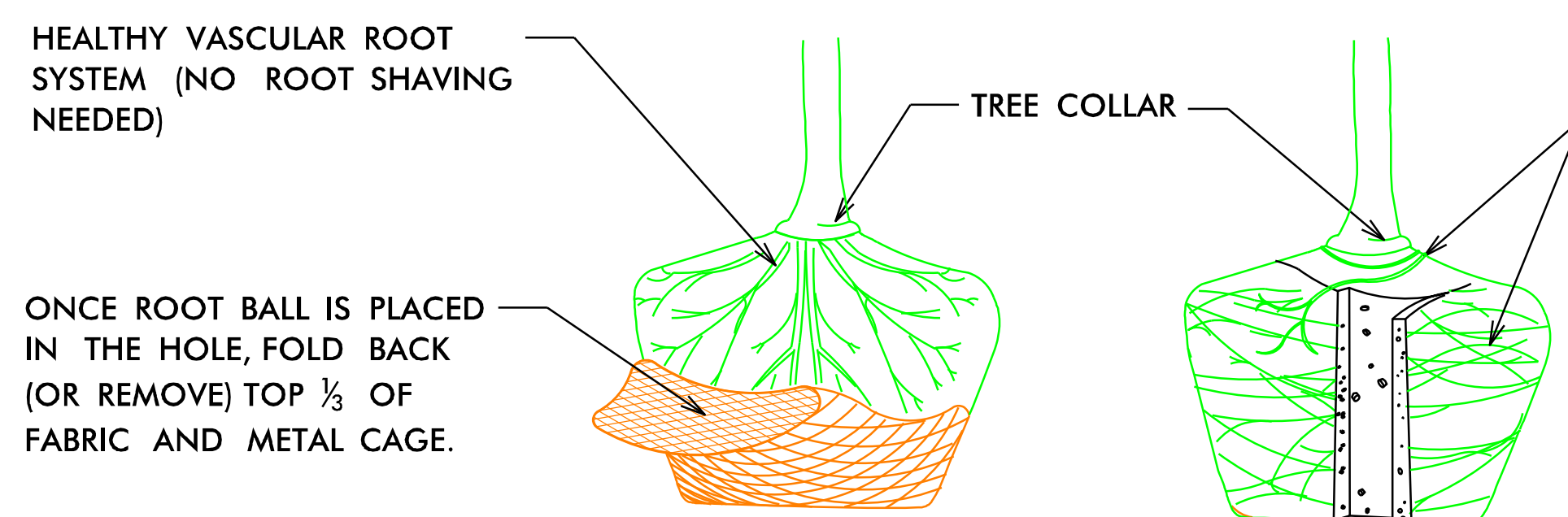

ROOT BALL SHAVING CAN BE PERFORMED JUST PRIOR TO PLANTING OR AFTER PLACING IN THE HOLE.

SHAVE OUTER PERIPHERY OF ROOT BALL (MAX. 2") WITH SHARP SPADE SHOVEL (OR HAND SAW) TO REMOVE GIRDLING ROOTS.

**TREE PLANTING INSTRUCTIONS
(FOR CONTAINER OR BALLED & BURLAPPED TREES)**

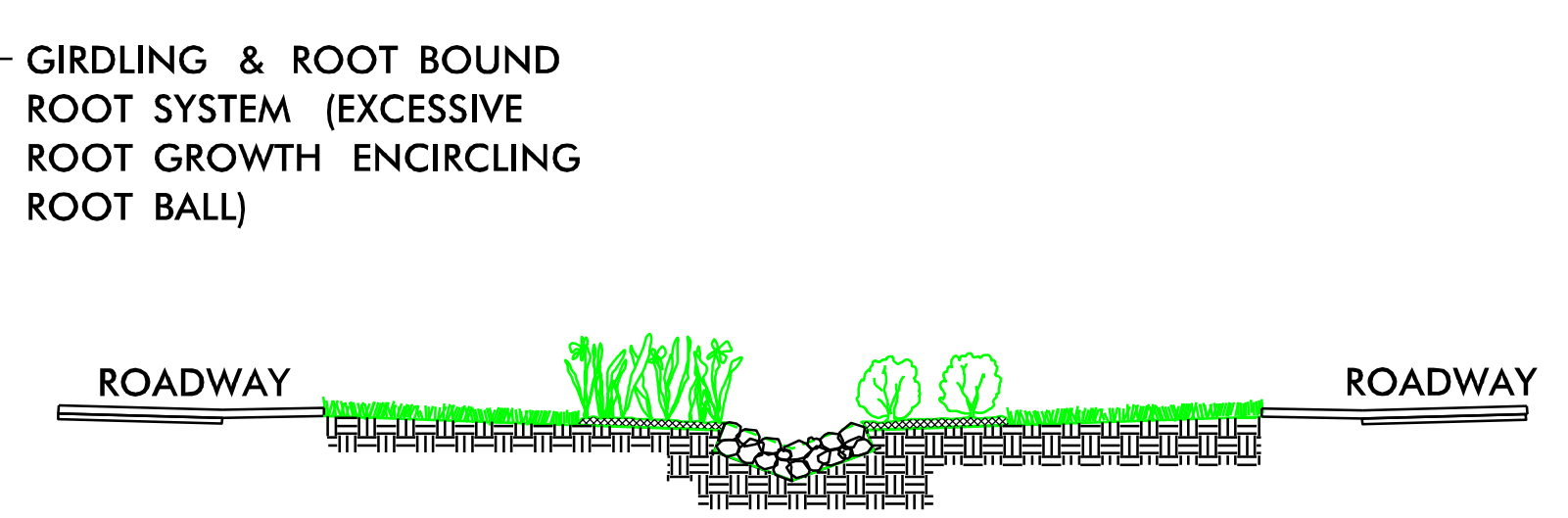

MIN. 12" DEEP CLASS "A" STONE ON FILTER FABRIC LINER IN DITCH. PLACE STONE FLUSH WITH DITCH GRADE FOR MAXIMUM WATER FLOW.

CLASS "A" STONE DITCH LINING DETAIL

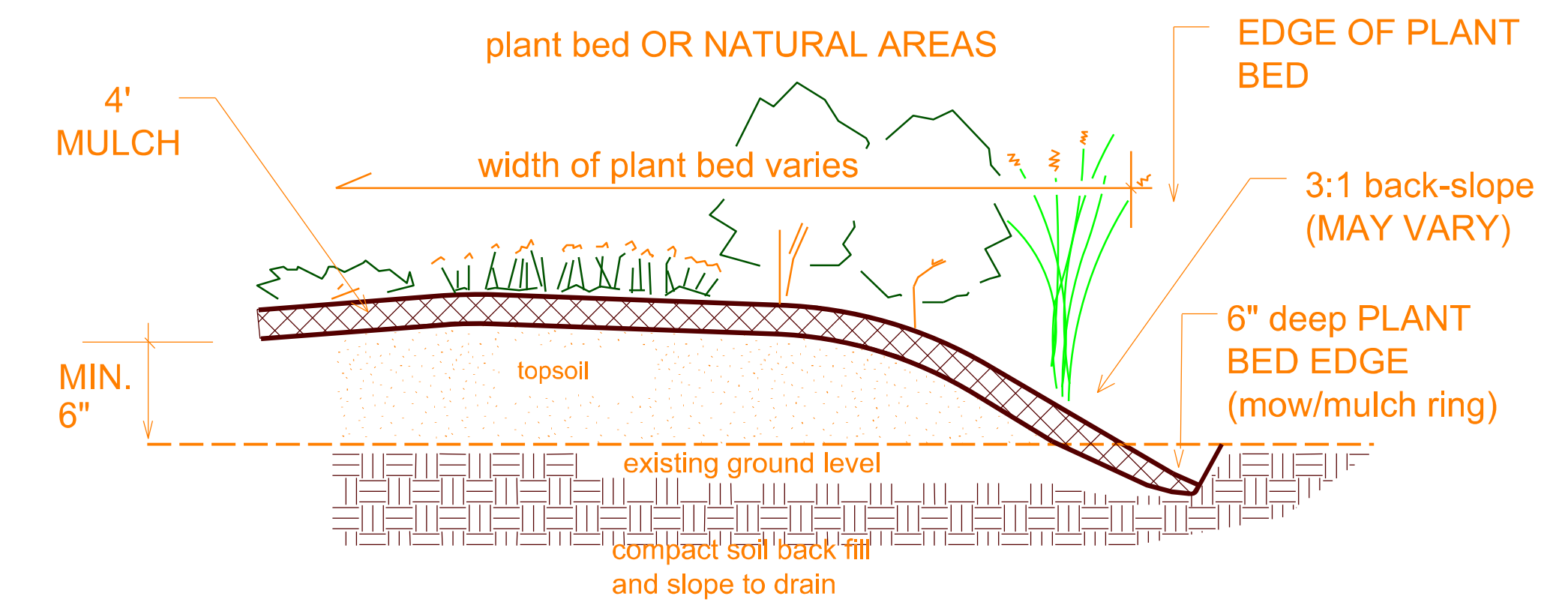

PLANT BED EDGE DETAIL

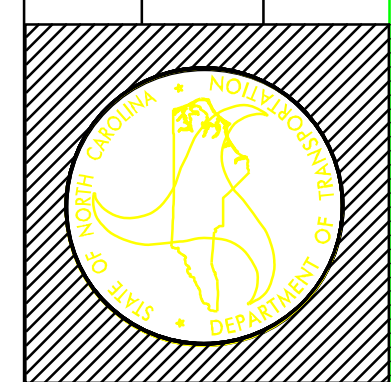



- CEDAR SLAT SIDING (ROOF)
- 4'X6' DECORATIVE REFLECTIVE SHEATHING ON ALUMINUM SIGN (SIGN SUPPLIED BY NCDOT)
- 6"X6" BREAK AWAY SUPPORT POSTS
- RIP-RAP STONE BASE (ADD SUPPORT AND PROTECT THE SIGN STRUCTURE)

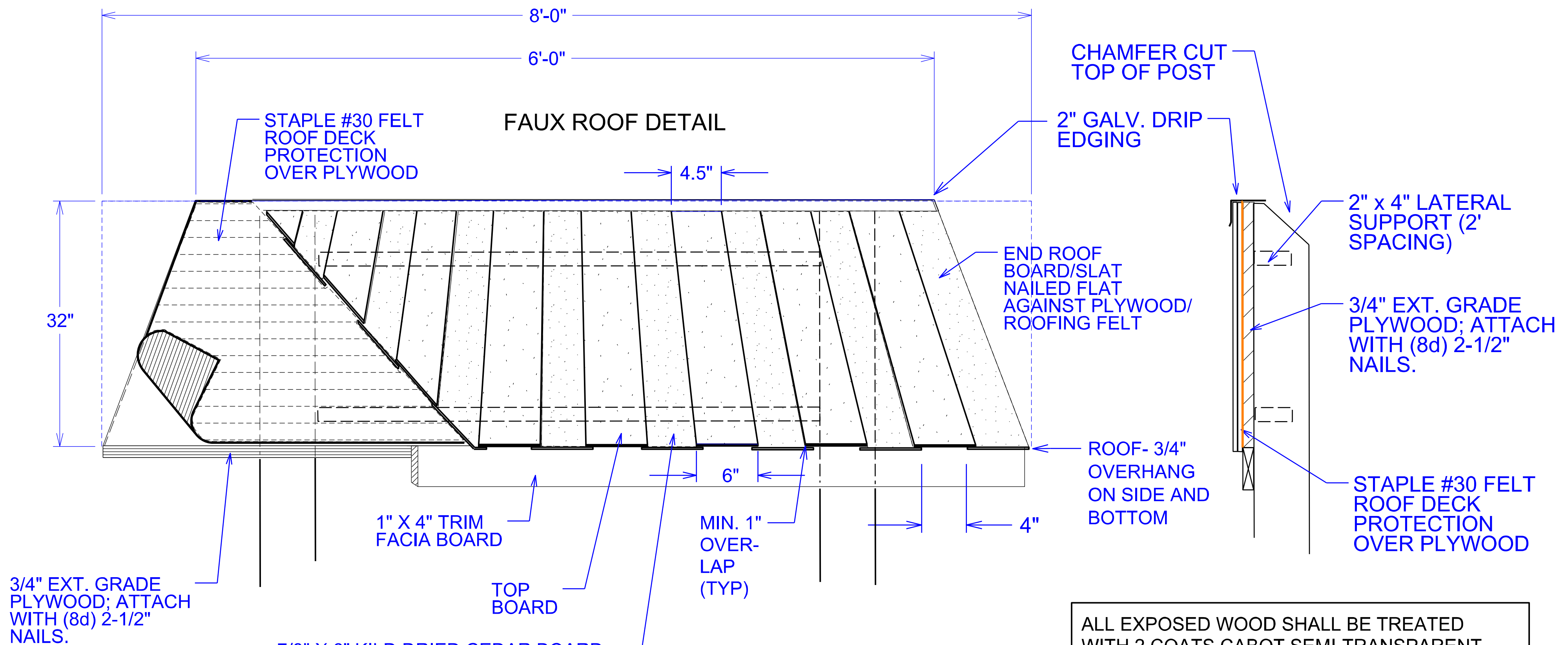

ALL EXPOSED WOOD SHALL BE TREATED WITH 2 COATS CABOT SEMI-TRANSPARENT 'SAGEBRUSH' CEDAR STAIN OR APPROVED EQUAL; FOLLOW MANUFACTURER GUIDELINES FOR PREPARATION AND APPLICATION.

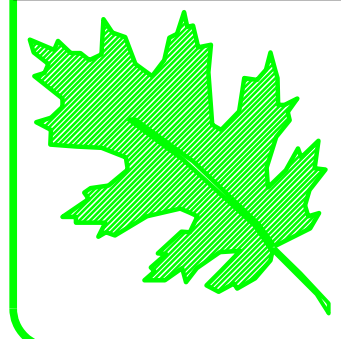
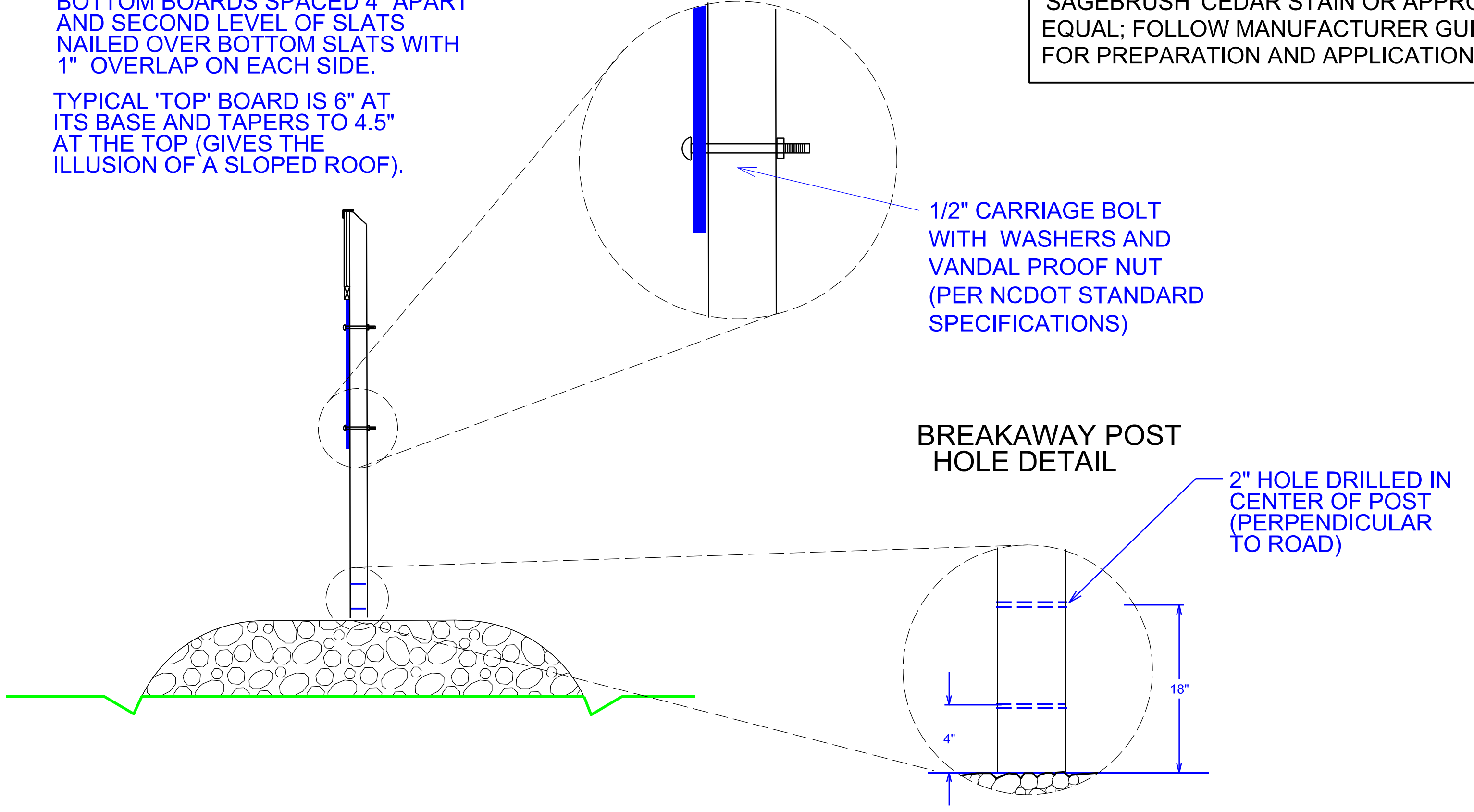
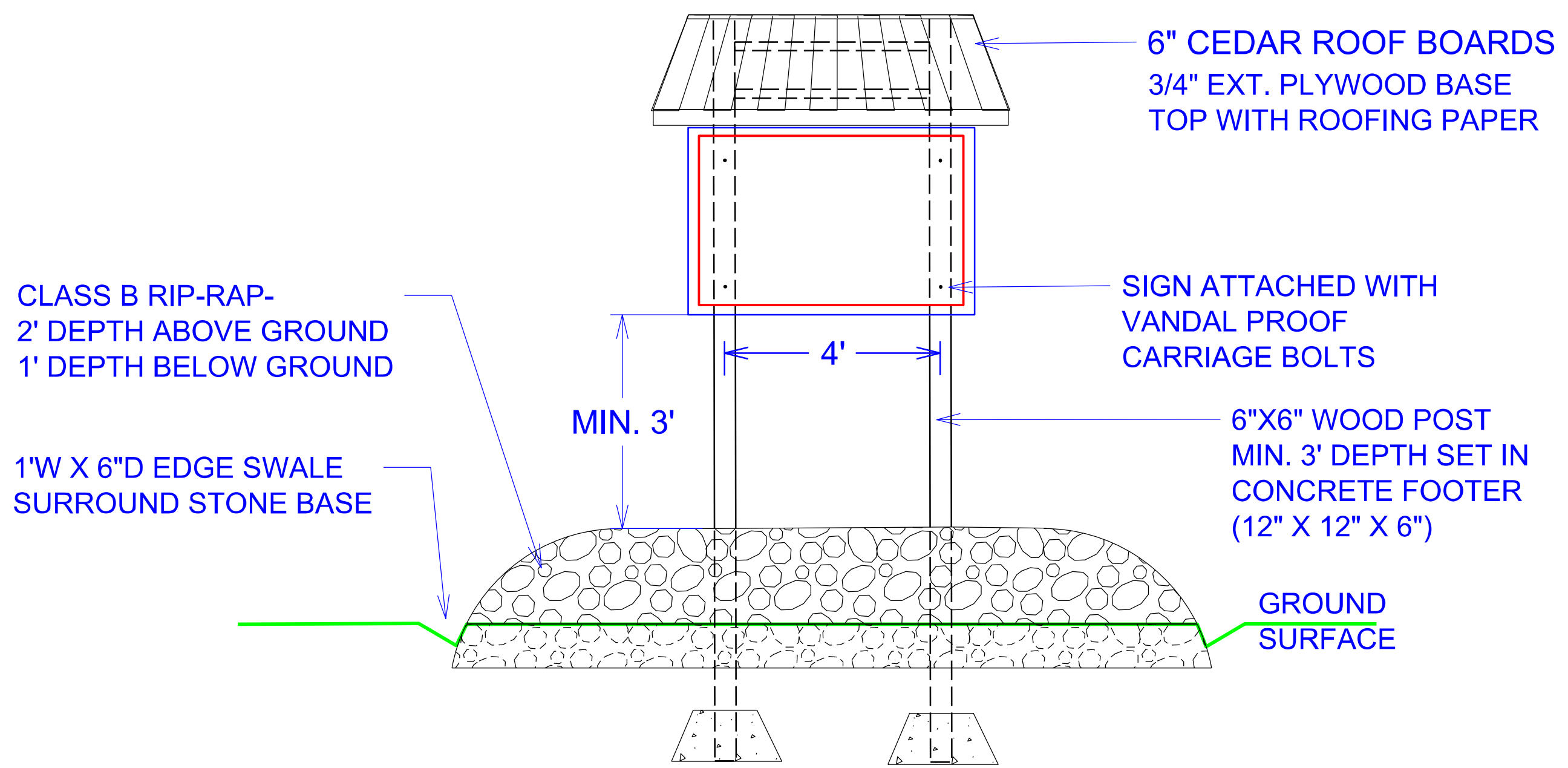

NCDOT - ROADSIDE ENVIRONMENTAL UNIT
AESTHETIC ENGINEERING SECTION
 1557 MAIL SERVICE CENTER, RALEIGH, NC 27699-1557
 PH: 919-707-2920 FAX: 919-715-2554
http://www.ncdot.org/doh/operations/dp_chief_eng/roadside/

NC 24 - R-2303A (L)
Autryville NC
 WBS#: 34416.3.12

reu engineer:

sheet description:
 LANDSCAPE ENHANCEMENT PLANS
 SIGN DETAILS

prel design date: 3-5-2020
 checked by & date:
 final design date: 4-8-2020

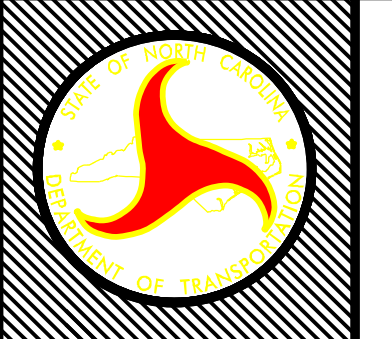

sheet no: L3
 total sheet no: 8

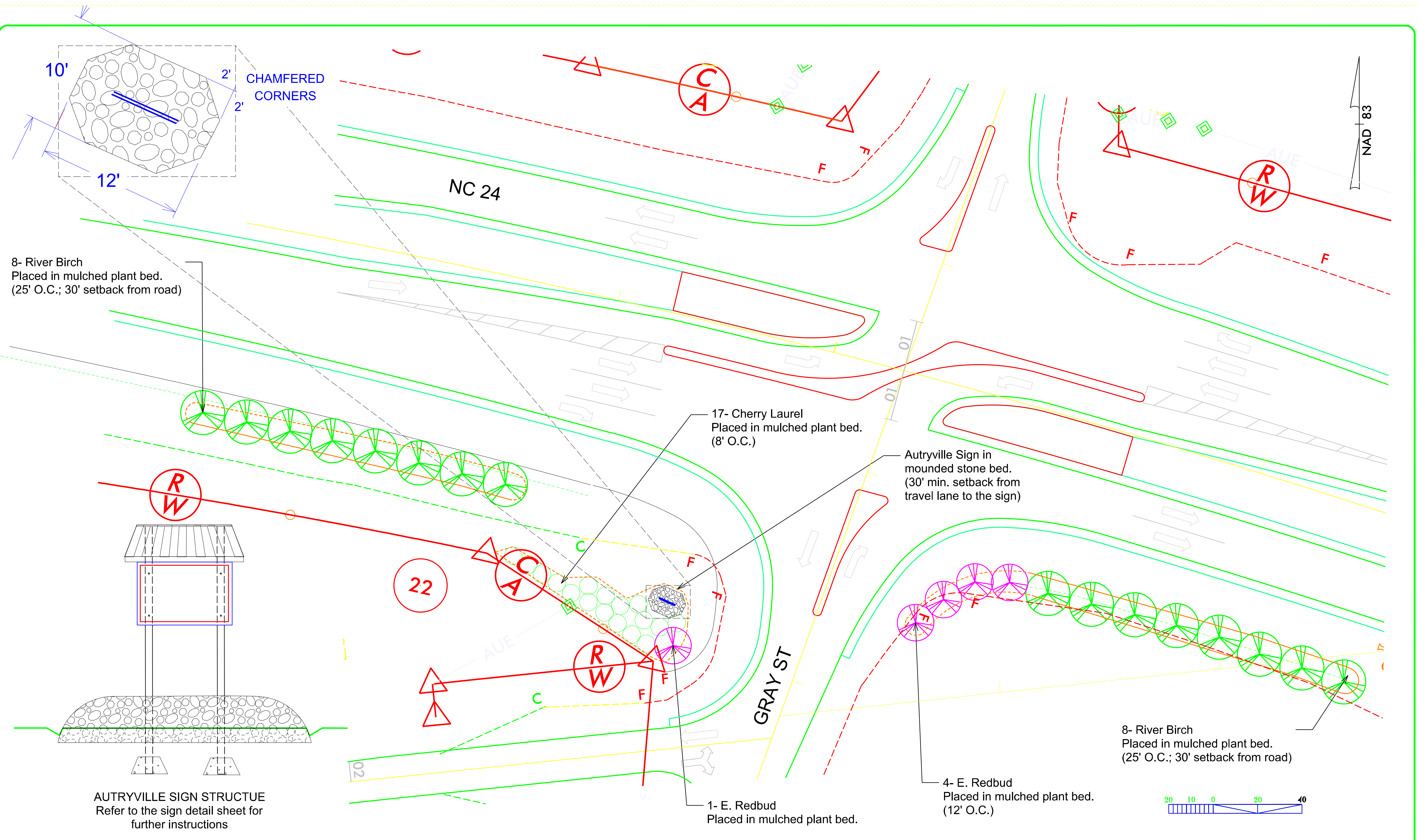

8- River Birch
Placed in mulched plant bed.
(25' O.C.; 30' setback from road)

17- Cherry Laurel
Placed in mulched plant bed.
(8' O.C.)

Autryville Sign in
mounded stone bed.
(30' min. setback from
travel lane to the sign)



8- River Birch
Placed in mulched plant bed.
(25' O.C.; 30' setback from road)

4- E. Redbud
Placed in mulched plant bed.
(12' O.C.)

1- E. Redbud
Placed in mulched plant bed.

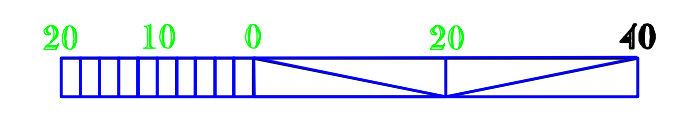
AUTRYVILLE SIGN STRUCTURE
Refer to the sign detail sheet for
further instructions

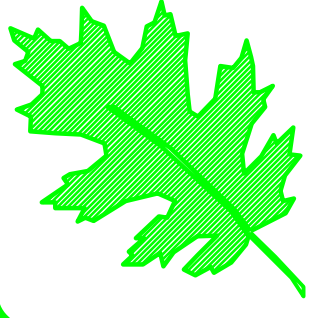

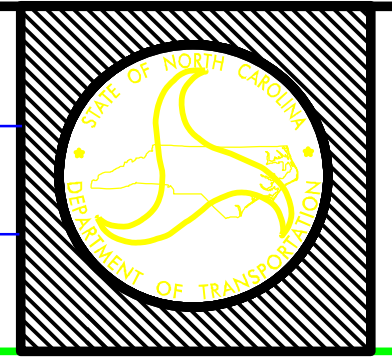
 <p>NCDOT - ROADSIDE ENVIRONMENTAL UNIT AESTHETIC ENGINEERING SECTION 1557 MAIL SERVICE CENTER, RALEIGH, NC 27699-1557 PH: 919-707-2920 FAX: 919-715-2554 http://www.ncdot.org/doh/operations/dp_chief_eng/roadside/</p>	<p>NC 24 - R-2303A (L) Autryville NC WBS#: 34416.3.12</p>	<p>reu engineer: </p>	<p>sheet description: Landscape Enhancement Plan NC 24 & Gray St- Autryville</p>	<p>prel design date: 3-5-2020 checked by & date: final design date: 4-8-2020</p>	<p>sheet no: L4 total sheet no: 8</p>
					

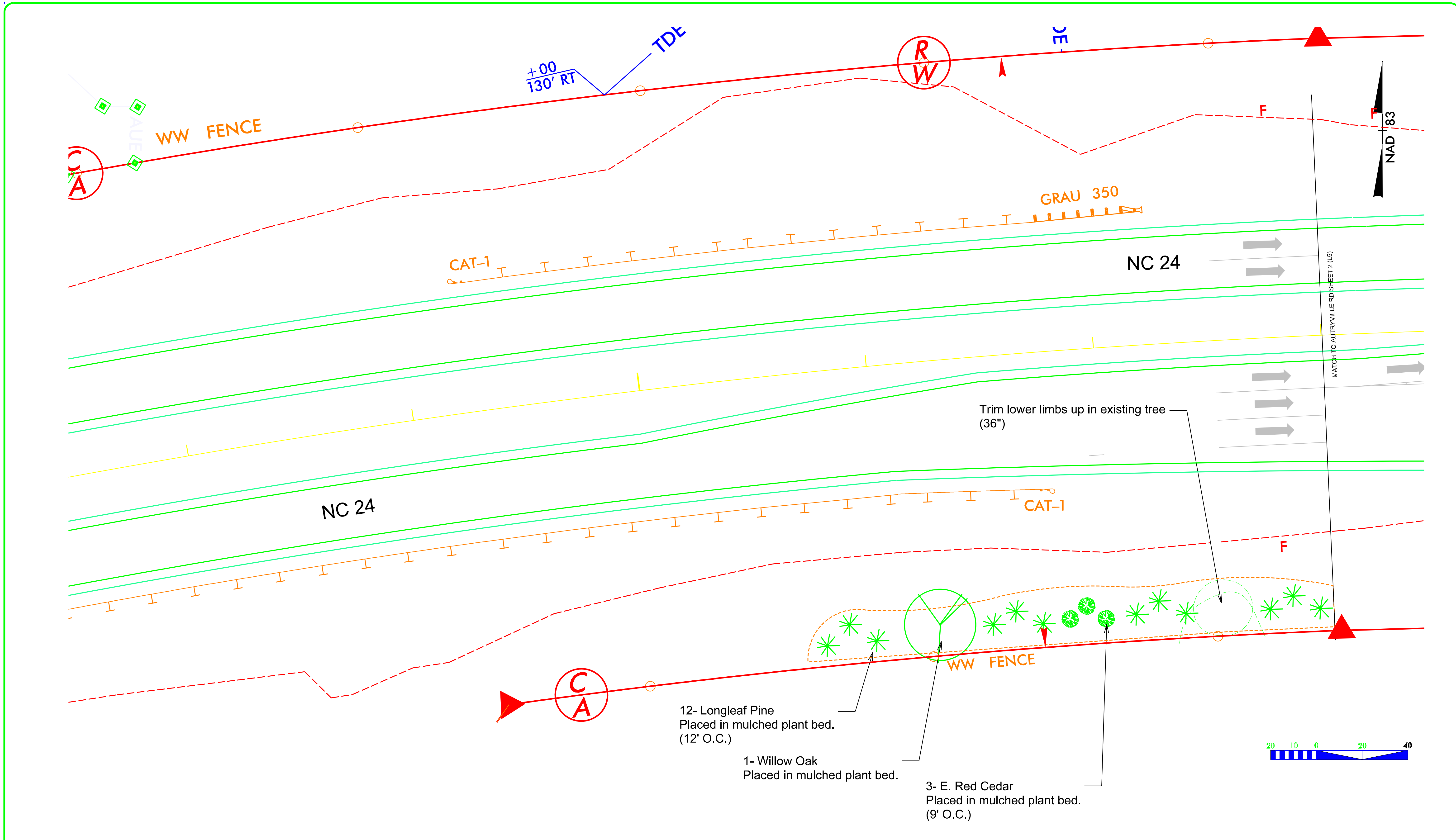

12- Logleaf Pine
Placed in mulched plant bed.
(12' O.C.)

1- Willow Oak
Placed in mulched plant bed.

3- E. Red Cedar
Placed in mulched plant bed.
(9' O.C.)

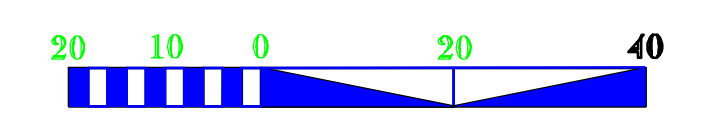

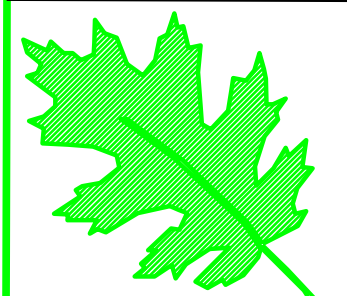
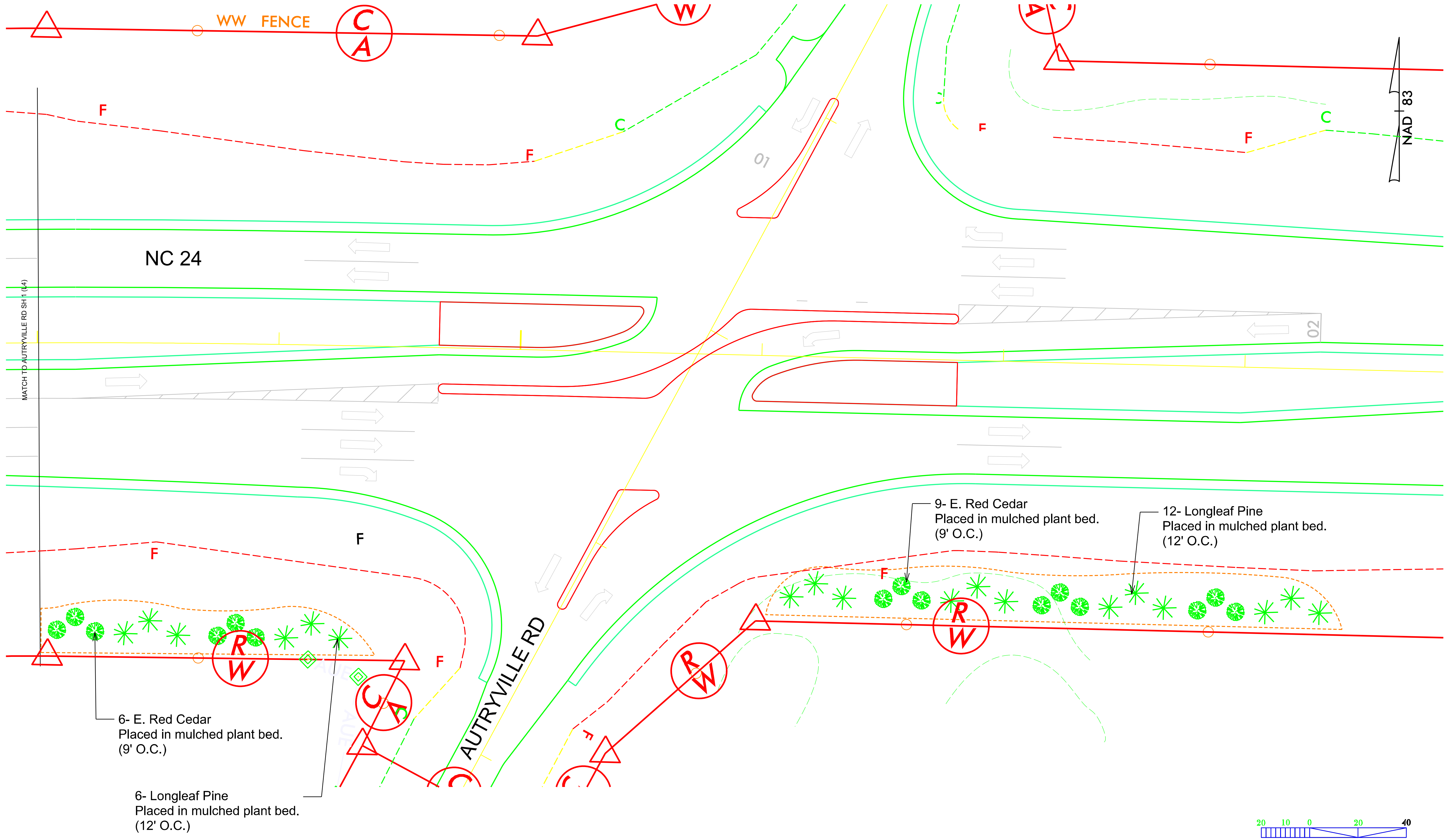

NCDOT - ROADSIDE ENVIRONMENTAL UNIT
AESTHETIC ENGINEERING SECTION
 1557 MAIL SERVICE CENTER, RALEIGH, NC 27699-1557
 PH: 919-707-2920 FAX: 919-715-2554
http://www.ncdot.org/doh/operations/dp_chief_eng/roadside/

NC 24 - R-2303A (L)
Autryville NC
WBS#: 34416.3.12

reu engineer:

sheet description:	Landscape Enhancement Plan
	NC 24 & Autryville Rd- Autryville

pref design date:	3-5-2020
checked by & date:	
final design date:	4-8-2020

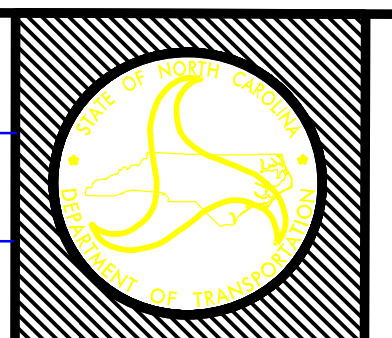

sheet no :
L6
 total sheet no : **8**

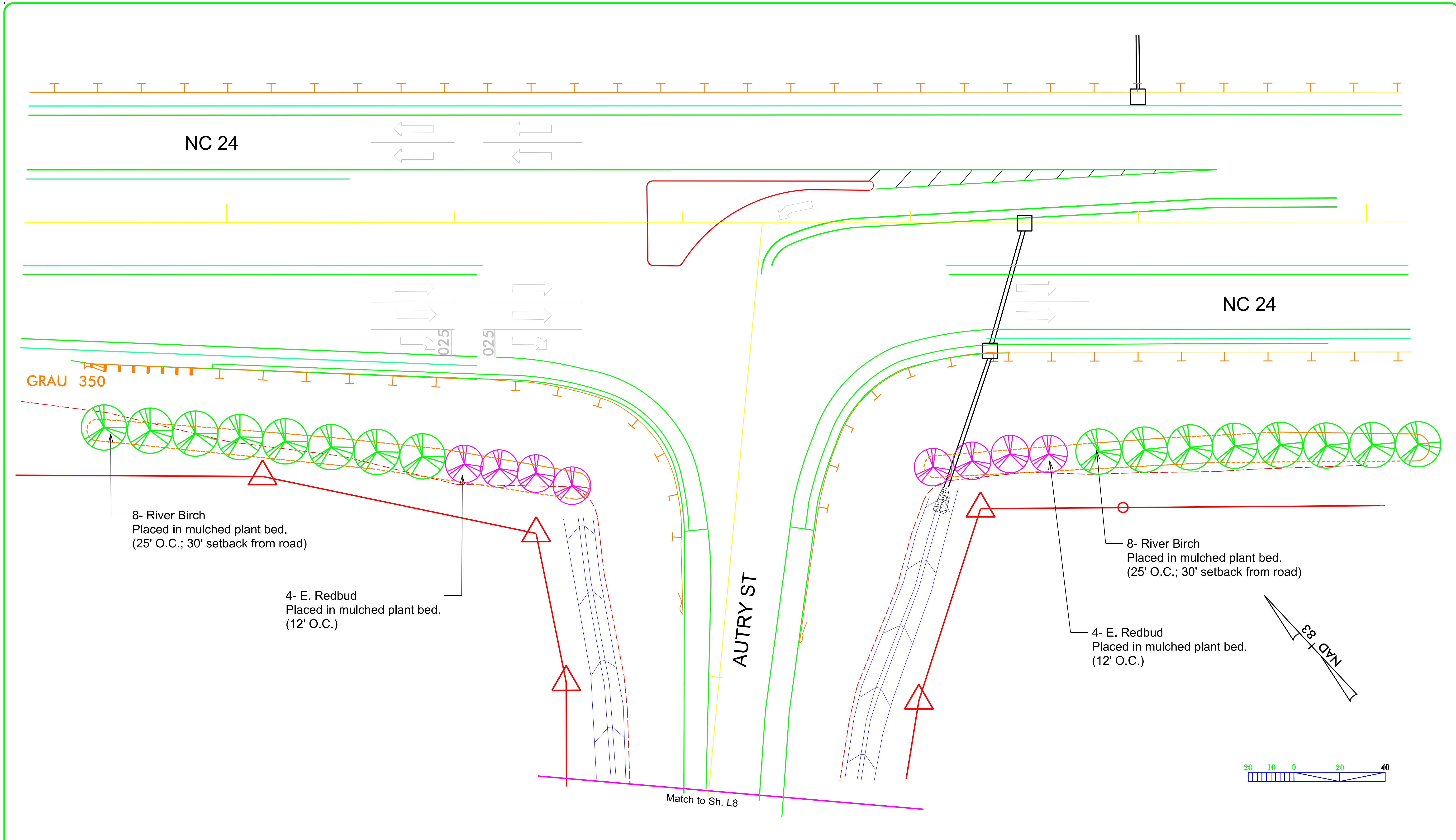



 NCDOT - ROADSIDE ENVIRONMENTAL UNIT
AESTHETIC ENGINEERING SECTION
 1557 MAIL SERVICE CENTER, RALEIGH, NC 27699-1557
 PH: 919-707-2920 FAX: 919-715-2554
http://www.ncdot.org/doh/operations/dp_chief_eng/roadside/

NC 24 - R-2303A (L)
Autryville NC
WBS#: 34416.3.12

reu engineer :

sheet description:
 Landscape Enhancement Plan
 NC 24 & Autry Rd- Autryville

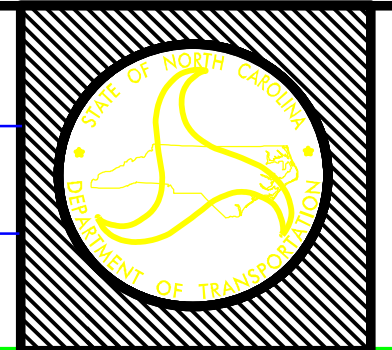
pre design date: **3-5-2020**
 checked by & date :
 final design date : **4-8-2020**

 sheet no : **L7**
 total sheet no : **8**

Match to Sh. L7

AUTRY RD

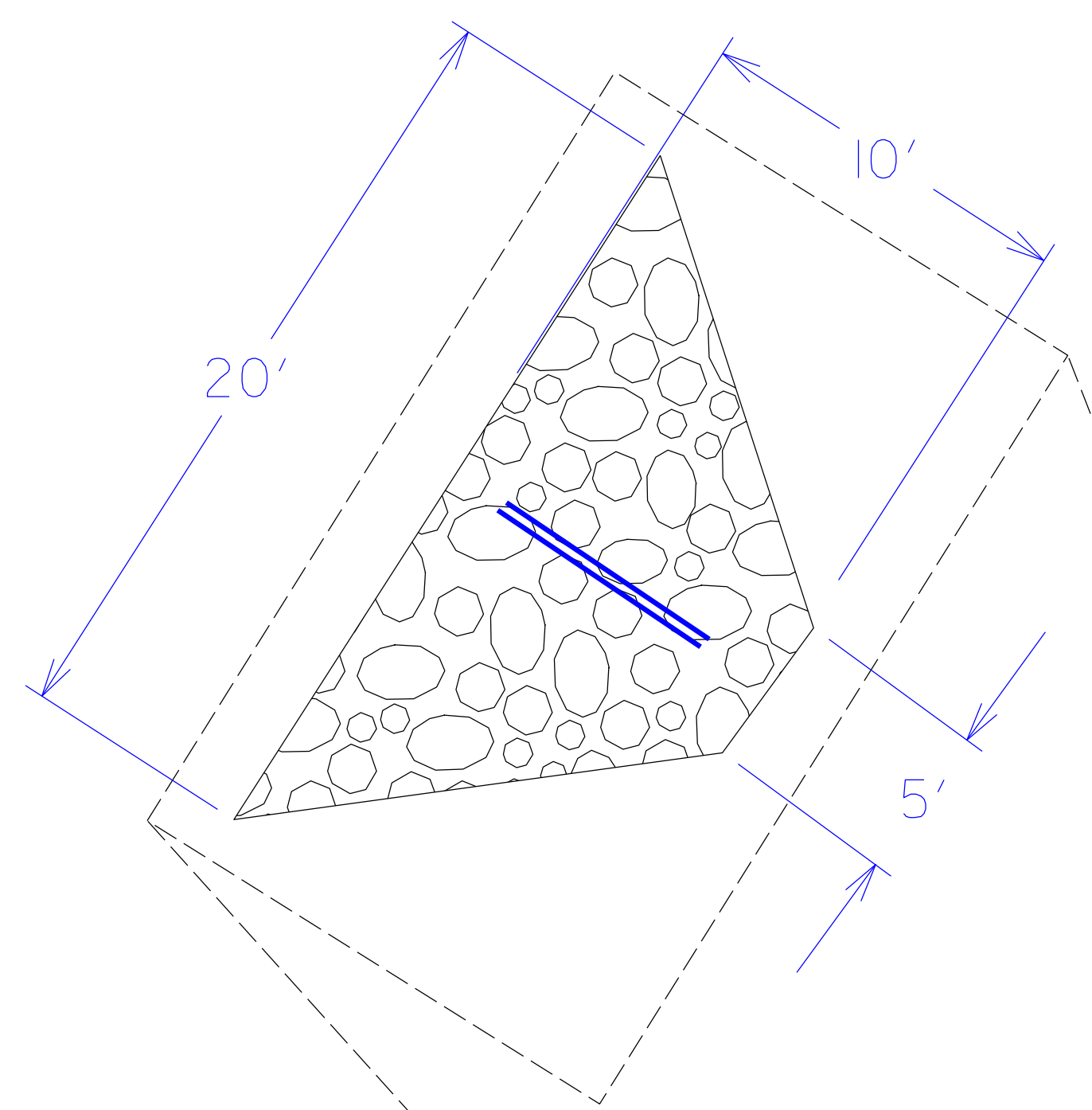

Autryville Sign in mounded stone bed. Sign placed min. 25' from travel lane. Incorporate flaired 18" pipe for drainage.

NCDOT Engineer shall confirm location prior to installation.

Maintain all safety sight lines.

DO NOT BLOCK DRAINAGE FLOW IN DITCH

SIGN POST (CLOSEST TO ROAD) SETBACK 25' FROM TRAVEL LANE

25' Setback

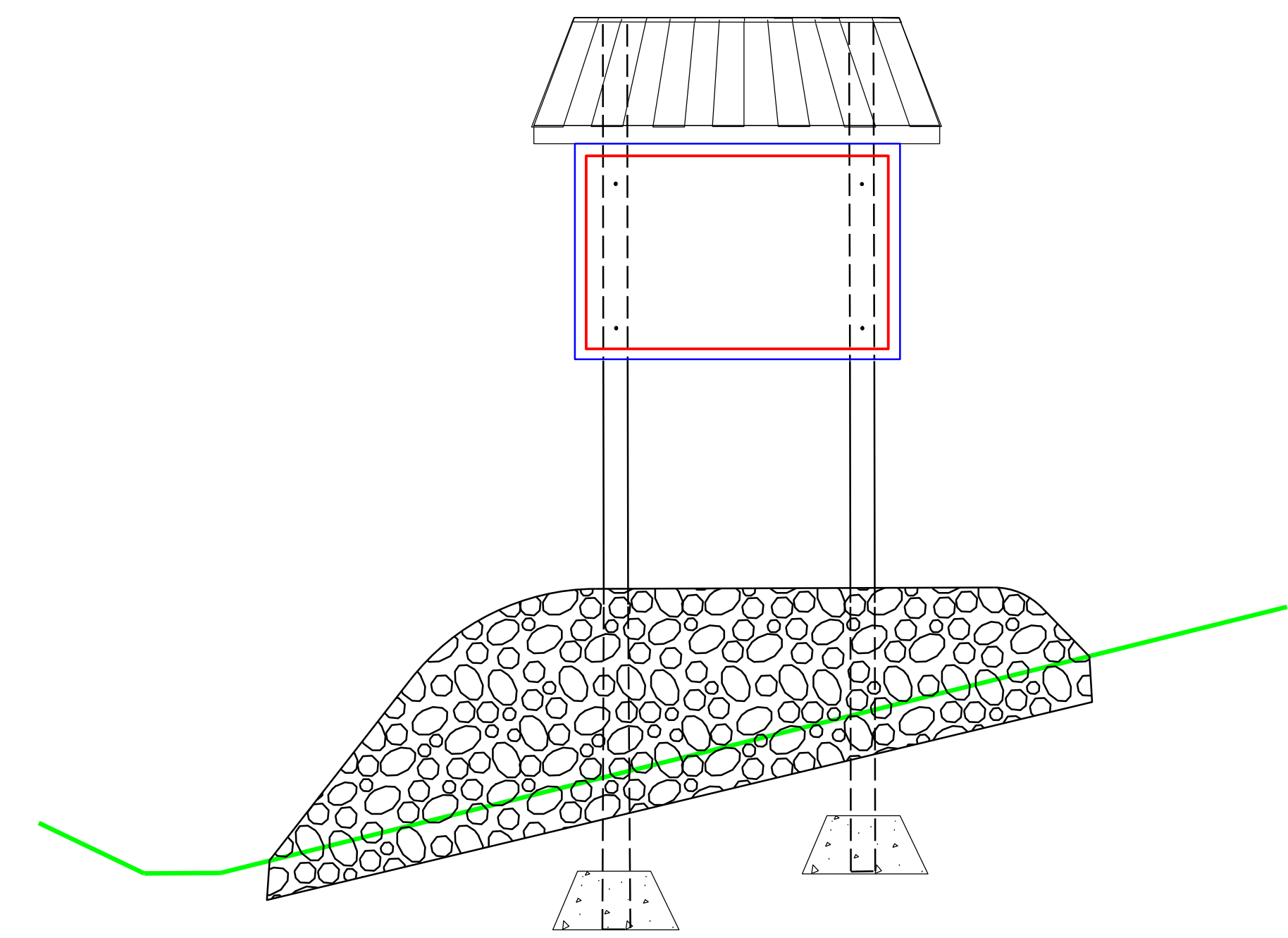

AUTRYVILLE SIGN STRUCTURE (on 4:1 SLOPE)
refer to sign detail sheet for further instructions

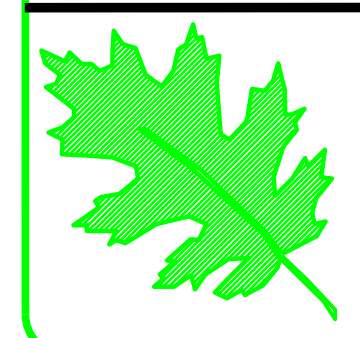
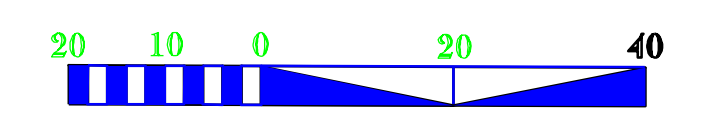
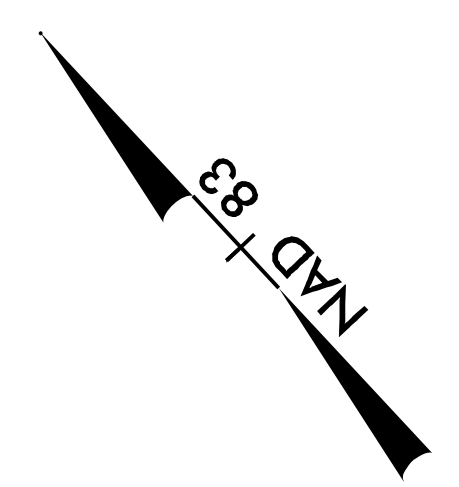

NCDOT - ROADSIDE ENVIRONMENTAL UNIT
AESTHETIC ENGINEERING SECTION
 1557 MAIL SERVICE CENTER, RALEIGH, NC 27699-1557
 PH: 919-707-2920 FAX: 919-715-2554
http://www.ncdot.org/doh/operations/dp_chief_eng/roadside/

NC 24 - R-2303A (L)
Autryville NC
WBS#: 34416.3.12

reu engineer :

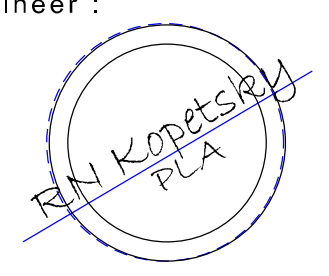

sheet description:	Landscape Enhancement Plan
	Autry Rd & Williams Rd

prel design date:	3-5-2020
checked by & date :	
final design date :	4-8-2020



sheet no :
L8
 total sheet no : **8**